

KIT ADDUZIONE INTERNA (OPZIONALE)  
 KIT FOR INTERNAL COOLANT (OPTIONAL)  
 KIT FUER INTERNE KUEHLMITTELZUFUHR (OPTIONAL)  
 Ø50 cod. KIT1002002

SOLO GUARNIZIONE (OPZIONALE)  
 ONLY SEAL (OPTIONAL)  
 NUR DICHTUNG (OPTIONAL)  
 cod. MNL0310005

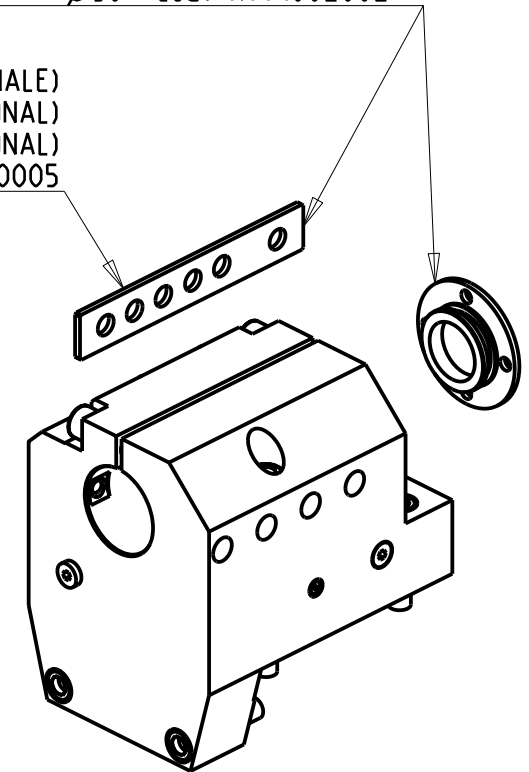

Cod. MT	N°Utensili N°Tools N°Werkzeuge	Lubrificazione int. opzionale Coolant through optional Innenkuehlung Optional	Lubrificazione est. Ext. coolant Aussenkuehlung	Misure Dimensions Masse	D	
DW04305000	1	X	X	mm	50	NEW

YCM  
 TC 46

PORTAUTENSILE ASSIALE PER BARENO Ø50mm H=85mm  
 Axial single boring bar holder Ø50mm H=85mm  
 Axial Bohrhälter Ø50mm H=85mm

Subject to change without notice.

**M.T. srl**  
 Via Casino Albini 480  
 Tel. 0541/956034-957884  
 Fax 0541/956341  
 47842 S. GIOVANNI IN M. (RN)  
 e-mail: mtma@mtmarchetti.com  
 http://www.mtmarchetti.com



YCM610-3-20