

KIT ADDUZIONE INTERNA (OPZIONALE)
 KIT FOR INTERNAL COOLANT (OPTIONAL)
 KIT FUER INTERNE KUEHLMITTELZUFUHR (OPTIONAL)
 Ø60 cod. KIT1003025

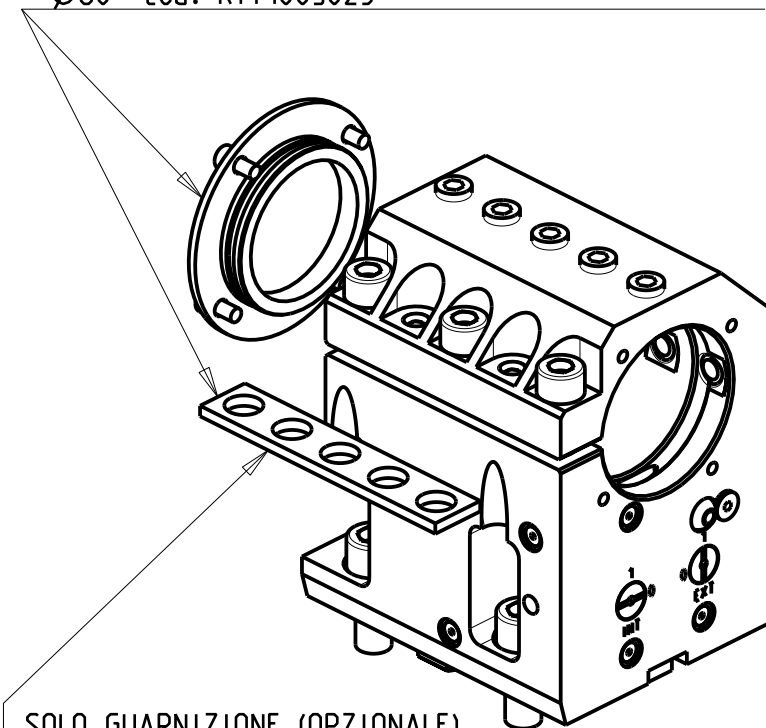

SOLO GUARNIZIONE (OPZIONALE)
 ONLY SEAL (OPTIONAL) NUR
 DICHTUNG (OPTIONAL) cod.
 0520013

Cod. MT	N°Utensili N°Tools N°Werkzeuge	Reversibile lato mandrino/contromandrino Reversible sub/main spindle side Umkehrbare Spindel-seite/ Gegenspindel-seite	Lubrificazione int. opzionale Coolant through optional Innenkuehlung Optional	Lubrificazione est. Ext. coolant Aussenkuehlung	Misure Dimensions Masse	D
DW00746000	1	X	X	X	mm	60

YCM
 MOD: BTX250SY - NT2000/2500 12 STAZIONI
 PORTAUTENSILE ASSIALE PER BARENO Ø60mm H=100mm
 Axial single boring bar holder Ø60mm H=100mm
 Axial Bohrhälter Ø60mm H=100mm

M.T. srl
 Via Casino Albini 480
 Tel. 0541/956034-957884
 Fax 0541/956341
 47842 S. GIOVANNI IN M. (RN)
 e-mail: mtma@mtmarchetti.com
 http://www.mtmarchetti.com



YCM590-2-20

Subject to change without notice.

03/2024