

-LA FUNZIONE DI POLIGONATURA/DENTATURA
DEVE ESSERE INSTALLATA SULLA MACCHINA
-POLYGON CUTTING/GEAR HOBBING FUNCTION
MUST BE INSTALLED ON THE MACHINE
-DIE FUNKTION FÜR POLYGON-BZW. VERZÄHNUNGSFRÄSEN
MUSS AUF DER MASCHINE FREIGESCHALTET WERDEN

ATTENZIONE - ATTENTION - ACHTUNG

- VERIFICARE LE MISURE DI INGOMBRO PER POSSIBILE INTERFERENZA SU ALCUNI MODELLI DI MACCHINE
- Please check the overall sizes for possible interferences on some machine models
- Bitte überprüfen sie das ausmass um mögliche interferenzen auf einigen maschinen modellen zu vermeiden

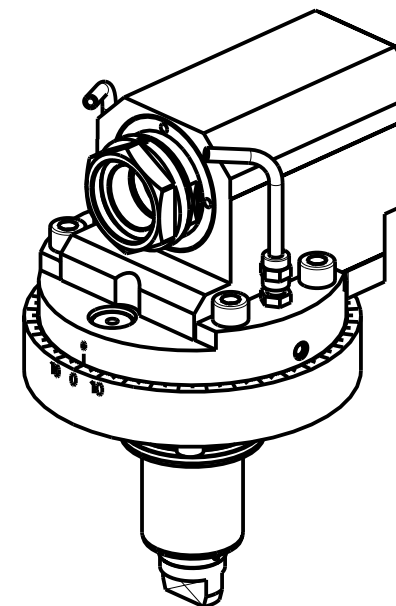
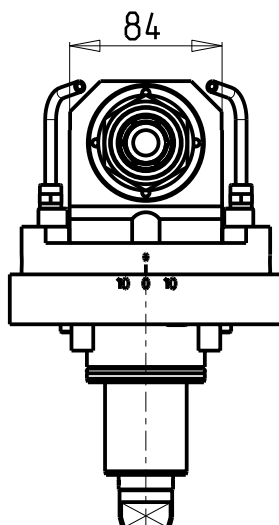
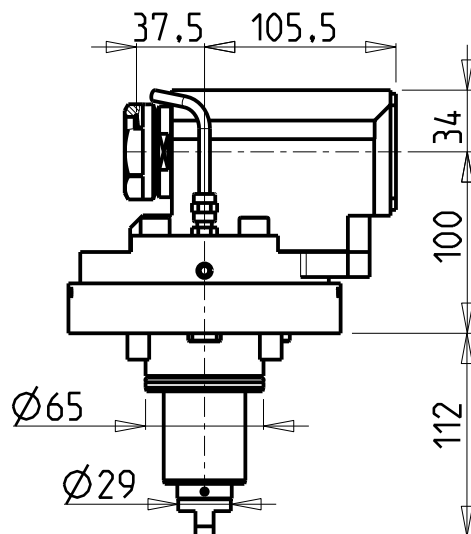

-SOLO PER MACCHINE CON ASSE Y
-ONLY FOR MACHINES WITH Y AXIS
-NUR FÜR MASCHINEN MIT Y-ACHSE

PER PORTAUTENSILI MODULARI MTSK-40 VEDI PAG. TBL300-1-40
FOR MTSK-40 QUICK CHANGE TOOLHOLDERS CLAMPINGS SEE PAGE TBL300-1-40
FÜR MTSK-40 MODULARE WERKZEUGAUFNAHMEN SIEHE SEITE TBL300-1-40

Cod. MT	Mandrino Spindle Spindel	I	RPM	Coppia Max Max Torque Max Drehmoment	Reversibile lato mandrino/contromandrino Reversible sub/main spindle side Umkehrbare Spindel-seite/Gegenspindel-seite	Lubr.esterna Ext. coolant Aussenkuehlung	CHIAVI INCLUSE Keys included Schluessel einbegriffen
DW01770100	MTSK-40	1:1	6000	50Nm	X	X	n°2 CHUB46

YCM
MOD: BTX250SY - NT2000/2500 12 STAZIONI
MODULO MOTORIZZATO ASSIALE MTSK PER POWER SKIVING H=100mm
Axial MTSK driven tool for Power Skiving H=100mm
Axial MTSK angetriebenes Werkzeug fuer Power Skiving H=100mm

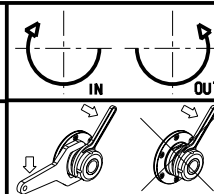

M.T. srl
Via Casino Albini 480
Tel. 0541/956034-957884
Fax 0541/956341
47842 S. GIOVANNI IN M. (RN)
e-mail: mtma@mtmarchetti.com
http://www.mtmarchetti.com

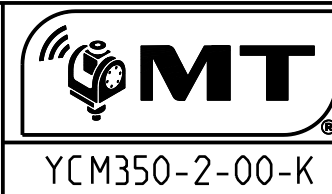

Subject to change without notice.

03/2024