

versione dx
right version
version rechts

versione sx
left version
version links

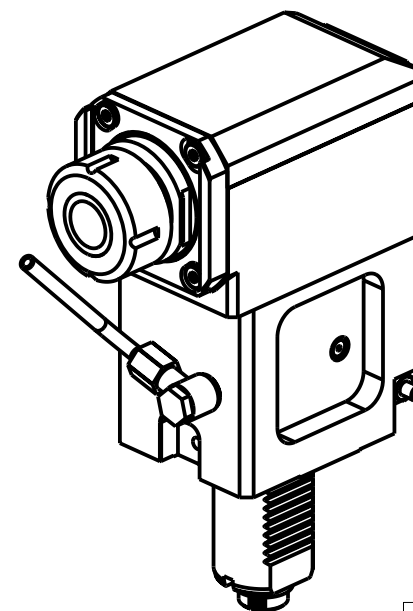
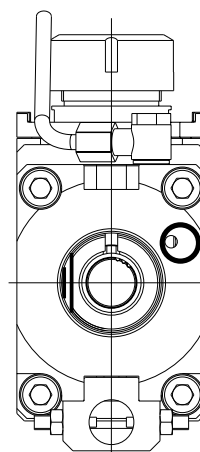
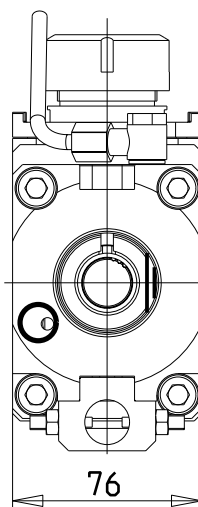

DIN 5480

- Chiave inclusa
- Key included
- Schlüssel inbegriffen

Cod. MT		Mandrino Spindle Spindel	I	RPM	Coppia Max Max Torque Max Drehmoment	Lubrificazione int. Coolant through Innenkuehlung	Lubrificazione est. Ext. coolant Aussenkuehlung	A	A1	B	D	L	CHIAVI NON INCLUDE Keys not included Schlüssel nicht einbegriffen	
versione dx right version version rechts	versione sx left version version links													
SAU0830132	SAU0831132	ER32	1:1	6000	70Nm	-	X	99.7	-	58.5	-	-	OKU0650004	CHSTER32
SAU0830232	SAU0831232	ER32	1:1	6000	70Nm	P=70bar	X	99.7	-	69.5	-	-	OKU0650004	CHSTER32
SAU0830140	SAU0831140	ER40	1:1	6000	70Nm	-	X	103.7	-	58.5	-	-	OKU0650004	CHSTER40
SAU0830240	SAU0831240	ER40	1:1	6000	70Nm	P=70bar	X	103.7	-	69.5	-	-	OKU0650004	CHSTER40
SAU0830522	SAU0831522	Ø22x19	1:1	6000	70Nm	-	X	-	78.5	58.5	22	19	CHUB41	CH_VTCROCE_M10
SAU0830527	SAU0831527	Ø27x21	1:1	6000	70Nm	-	X	-	78.5	58.5	27	21	CHUB41	CH_VTCROCE_M12

SAUTER
VDI 40

MODULO MOTORIZZATO RADIALE VDI40 DIN 5480 H=130mm
Radial driven tool VDI40 DIN 5480 H=130mm
Radial angetriebenes Werkzeug VDI40 DIN 5480 H=130mm

Subject to change without notice.

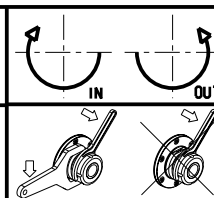

M.T. srl

Via Casino Albini 480
Tel. 0541/956034-957884
Fax 0541/956341
47842 S. GIOVANNI IN M. (RN)
e-mail: mtma@mtmarchetti.com
http://www.mtmarchetti.com



SAU018-3-20