

Ø16
TOOL DIAMETER

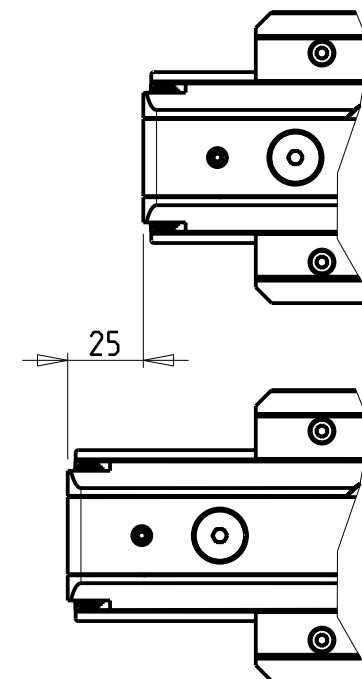
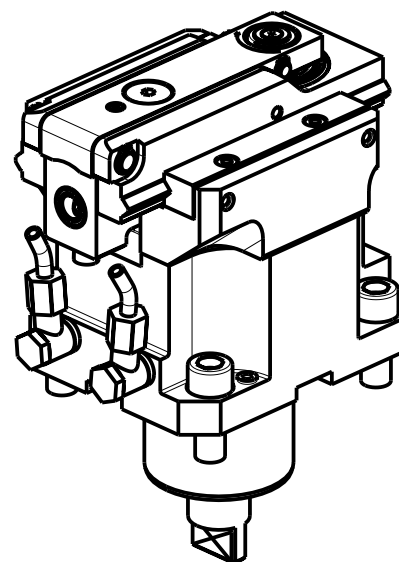

DOTAZIONI - SUPPLIED WITH - AUSSTATTUNG

N*1 Boccola di riduz. Ø16-Ø12 e N*1 Boccola di riduz. Ø16-Ø10
 N*1 Reduction bush Ø16-Ø12 and N*1 Reduction bush Ø16-Ø10
 N*1 Reduzierbuchsen Ø16-Ø12 und N*1 Reduzierbuchsen Ø16-Ø10

PER UTENSILI STOZZATORI VEDI PAG. TBL400-1-00
 FOR DRIVEN SLOTTING TOOL CUTTING-TOOLS SEE PAGE TBL400-1-00
 FÜR NUTENSTOSS-WERKZEUG SCHNEIDWERKZEUGE SIEHE SEITE TBL400-1-00

Cod. MT	I	RPM MAX	Reversibile lato mandrino/contromandrino Reversible sub/main spindle side Umkehrbare Spindelseite/ Gegenspindelseite	Lubr. esterna Ext. coolant Aussenkuehlung
MNL0650200	4:1	2400	X	X

TAKISAWA
 MOD: TS3000/4000/5000 Y/YS 12 ST. (3 KEYS TURRET)
 MODULO MOTORIZZATO STOZZATORE CORSA 25mm H=94mm
 Slotting driven tool 25mm stroke H=94mm
 Keilnutenstossmaschine 25mm Hub H=94mm

M.T. srl
 Via Casino Albini 480
 Tel. 0541/956034-957884
 Fax 0541/956341
 47842 S. GIOVANNI IN M. (RN)
 e-mail: mtma@mtmarchetti.com
 http://www.mtmarchetti.com



TKW 360-7-01

Subject to change without notice.

09/2024