

versione dx
right version
version rechts

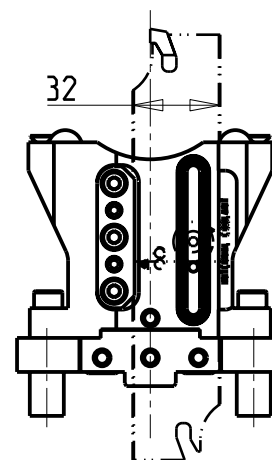

versione sx
left version
version links

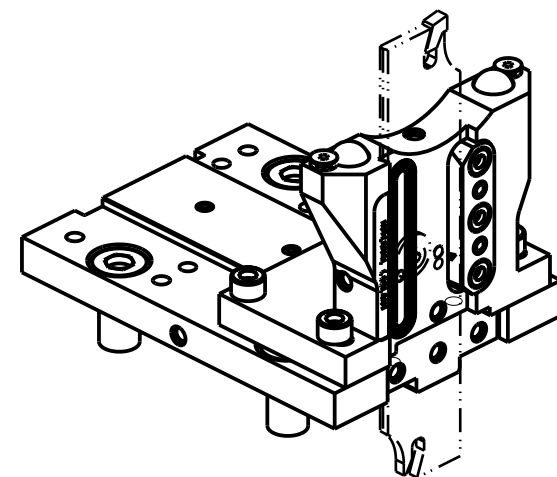

**KIT LAME NON INCLUSI (OPZIONALI)
BLADES NOT SUPPLIED WITH (OPTIONAL)
KLINGEN NICHT INBEGRIFFEN (OPTIONAL)**

- LAMA-BLADE-KLINGE SANDVIK H=32 sp.3 cod. QD_NN2G60C 25A
+INSERTI-INSERTS-EINLAGEN cod. QD_NG_0300_0002_CM_1145 (10 pz.)
- LAMA-BLADE-KLINGE SANDVIK H=32 sp.4 cod. QD_NN2H60C 25A
+INSERTI-INSERTS-EINLAGEN cod. QD_NH_0400_0002_CM_1145 (10 pz.)
- LAMA-BLADE-KLINGE ISCAR H=32 sp.3 cod. SGFH_32K_3
+INSERTI-INSERTS-EINLAGEN cod. 6011365 (10pz.)
- LAMA-BLADE-KLINGE ISCAR H=32 sp.4 cod. SGFH_32K_4
+INSERTI-INSERTS-EINLAGEN cod. 6011366 (10pz.)
- LAMA-BLADE-KLINGE WALTER H=32 sp.3 cod. G2042.32N-3T45SX-P
+INSERTI-INSERTS-EINLAGEN cod. SX-3E300N02-CE4 WSM33S (10pz.) + CHIAVE-KEY cod. FS1494
- LAMA-BLADE-KLINGE WALTER H=32 sp.4 cod. G2042.32N-4T50SX-P
+INSERTI-INSERTS-EINLAGEN cod. SX-4E400N02-CE4 WSM33S (10pz.) + CHIAVE-KEY cod. FS1494

Cod. MT

versione dx right version version rechts	versione sx left version version links	N°Utensili N°Tools N°Werkzeuge	Reversibile lato mandrino/contromandrino Reversible sub/main spindle side Umkehrbare Spindel-seite/ Gegenspindel-seite	Lubr.esterna Ext. coolant Aussenkuehlung	Lubr.interna Coolant through Innenkuehlung
DW 01730132R	DW 01730132L	1	X	X	P=70bar

SPINNER

MOD: TC800 SMCY - TTS85/125 12ST. (BMT65)

PORTAUTENSILE RADIALE PER LAMA CON LUBRIFICAZIONE INTERNA

Radial blade holder with internal coolant

Radial Abstechhalter mit Innenkuehlung

Subject to change without notice.

M.T. srl

Via Casino Albini 480
Tel. 0541/956034-957884
Fax 0541/956341
47842 S. GIOVANNI IN M. (RN)
e-mail: mtma@mtmarchetti.com
http://www.mtmarchetti.com



SPN520-2-05

03/2024