

PER ORDINARE LA VERSIONE SX
 AGGIUNGERE "LC" AL CODICE IN TABELLA.
 ES: MNL0464010 DIVENTA MNL0464010LC

TO ORDER LEFT VERSION
 ADD A "LC" IN THE CODE-CHARTS.
 EXAMPLE: MNL0464010 BECOMES MNL0464010LC

UM DIE LINKE-VERSION ZU BESTELLEN, BEI DER
 ARTIKELBEZEICHNUNG "LC" HINZUFUEGEN.
 BEISPIEL: MNL0464010 WIRD DANN MNL0464010LC

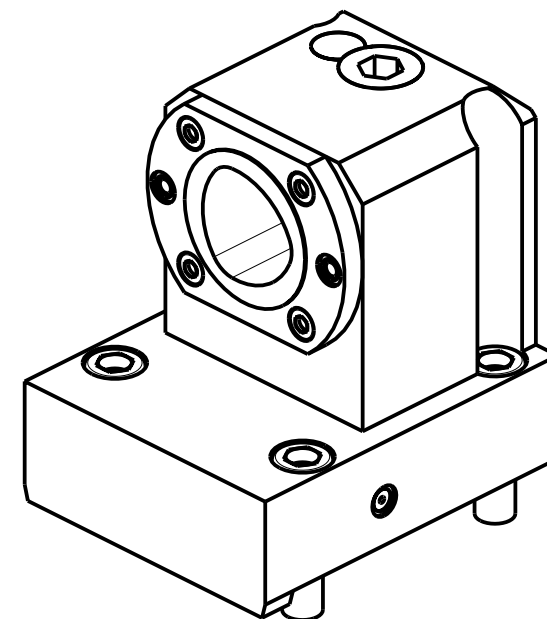

Cod. MT	N°Utensili N°Tools N°Werkzeuge	Lubrificazione int. Coolant through Innenkuehlung	Lubrificazione est. Ext. coolant Aussenkuehlung	Reversibile lato mandrino/contromandrino Reversible sub/main spindle side Umkehrbare Spindel-seite/ Gegenspindel-seite	TAGLIA Size Masse
OKU0635010	1	X	X	X	C5

OKUMA

MOD: LB4000EX(I) - LB4000EX(II) - LU4000EX

PORTAUTENSILE ASSIALE SINGOLO ARRETRATO MT CAPTO

Axial rear-set single static tool MT CAPTO

Axial Single-Werkzeughalter zurueckversetzt MT CAPTO

Subject to change without notice.

M.T. srl

Via Casino Albini 480
 Tel. 0541/956034-957884
 Fax 0541/956341

47842 S. GIOVANNI IN M. (RN)
 e-mail: mtma@mtmarchetti.com
 http://www.mtmarchetti.com



OKU555-E-50

03/2024