

KIT ADDUZIONE INTERNA (OPZIONALE)
 KIT FOR INTERNAL COOLANT (OPTIONAL)
 KIT FUER INTERNE KUEHLMITTELZUFUHR (OPTIONAL)
 Ø32 cod. KIT1000035

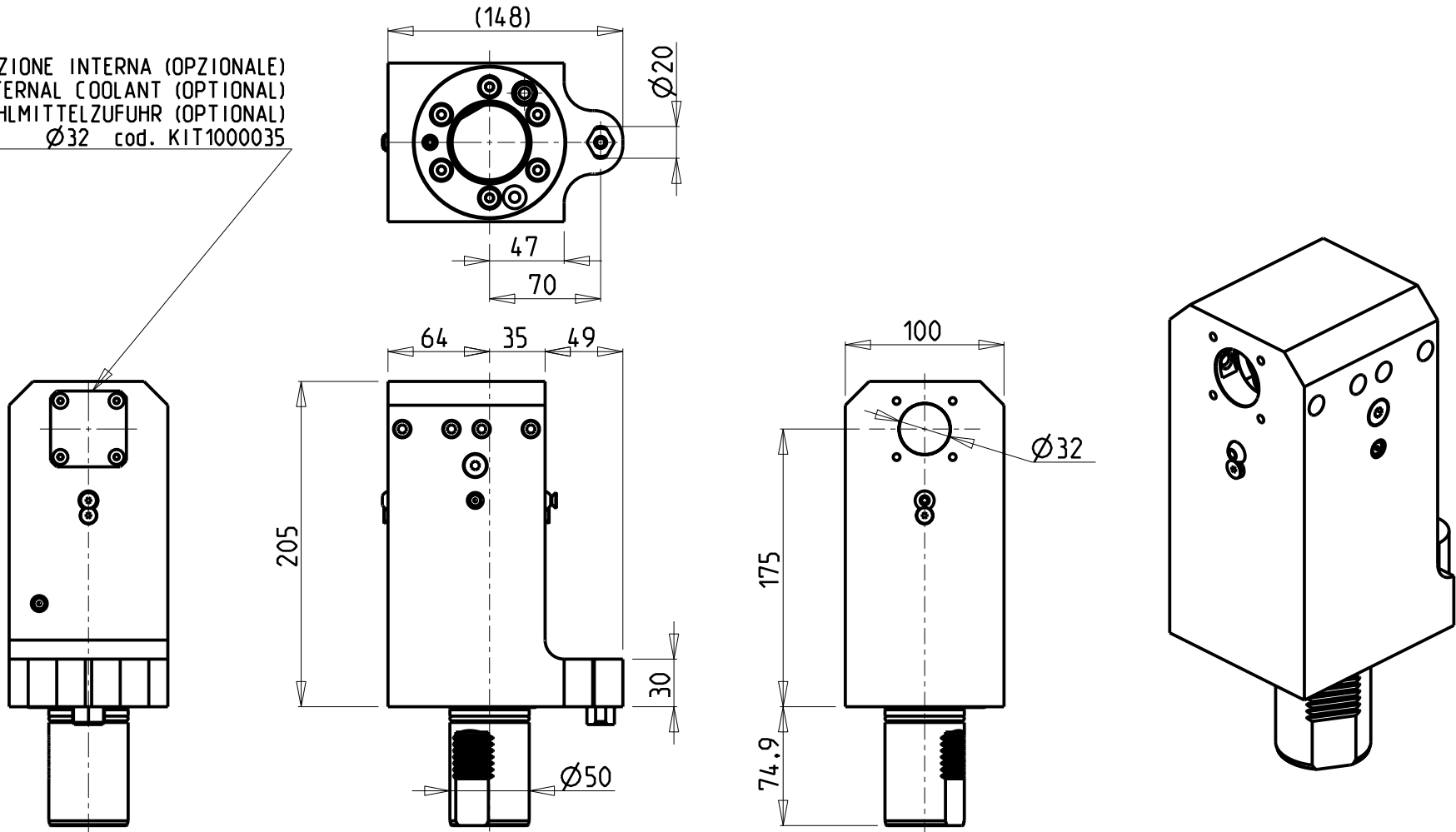

PER BOCCOLE DI RIDUZIONE VEDI PAG. TBL150-1-00
 FOR REDUCING BUSHINGS SEE PAGE TBL150-1-00
 FÜR REDUZIERBUCHSE SIEHE SEITE TBL150-1-00

Cod. MT	N°Utensili N°Tools N°Werkzeuge	Lubrificazione int. opzionale Coolant through optional Innenkühlung Optional	Lubrificazione est. Ext. coolant Aussenkühlung	Misure Dimensions Masse
MZK0993200	1	X	X	mm

MAZAK
 QT NEXUS 300/350/400/450M/MY - QT NEXUS 30011/35011/40011/45011 M/MY - SQT 28/30 - MEGATURN NEXUS 900M
 SLANT TURN NEXUS 500/550M - UNIVERSAL 2000/3000 M - HYPER QUADREX 450M - SQT 300/350/400/450M/MY

PORTAUTENSILE ASSIALE PER BARENO Ø32mm H=175mm
 Axial single boring bar holder Ø32mm H=175mm
 Axial Bohrhälter Ø32mm H=175mm

M.T. srl
 Via Casino Albini 480
 Tel. 0541/956034-957884
 Fax 0541/956341
 47842 S. GIOVANNI IN M. (RN)
 e-mail: mtma@mtmarchetti.com
 http://www.mtmarchetti.com



MZK650-5-10

Subject to change without notice.

03/2024