

KIT ADDUZIONE INTERNA (OPZIONALE)
 KIT FOR INTERNAL COOLANT (OPTIONAL)
 KIT FUER INTERNE KUEHLMITTELZUFUHR (OPTIONAL)
 Ø80 cod. KIT1005013

SOLO GUARNIZIONE (OPZIONALE)
 ONLY SEAL (OPTIONAL)
 NUR DICHTUNG (OPTIONAL)
 cod. MNL0620002

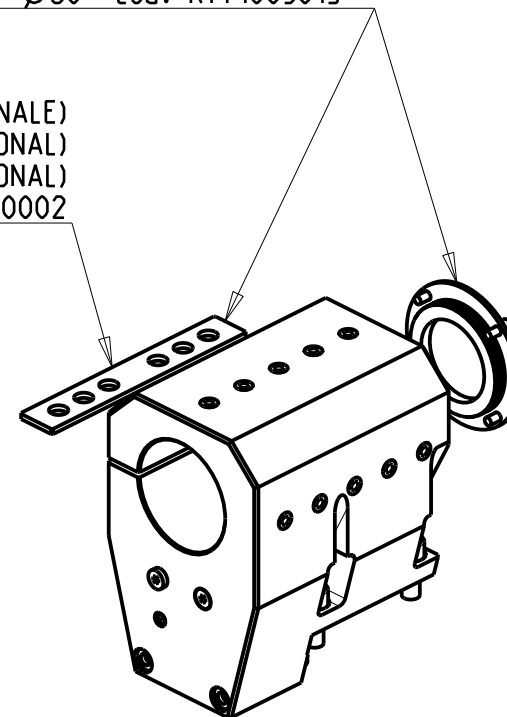

Cod. MT	N°Utensili N°Tools N°Werkzeuge	Lubrificazione int. opzionale Coolant through optional Innenkuehlung Optional	Lubrificazione est. Ext. coolant Aussenkuehlung	Misure Dimensions Masse	D
DW00848000	1	X	X	mm	80

DN SOLUTIONS (DOOSAN) BMT 75

MOD: PUMA 400 - PUMA 480M/LM/XLM - PUMA 4100M - PUMA 5100M/Y - V550M

PORTAUTENSILE ASSIALE PER BARENO Ø80mm H=110mm

Axial single boring bar holder Ø80mm H=110mm

Axial Bohrhalter Ø80mm H=110mm

Subject to change without notice.

M.T. srl

Via Casino Albini 480
 Tel. 0541/956034-957884
 Fax 0541/956341

47842 S. GIOVANNI IN M. (RN)
 e-mail: mtma@mtmarchetti.com
 http://www.mtmarchetti.com



DW 0580-4-20

03/2024